

Semantic Web Technologies

Semantic Web Vocabularies and Applications

Jos de Bruijn

`debruijn@inf.unibz.it`

KRDB Research Group
Free University of Bolzano, Italy

09 May 2007

Outline

RDF Applications

- RDF stores

- RDF vocabularies

- Connecting Web and Semantic Web

- GRDDL

Using F-Logic for Modeling Test Cars

- ▶ Jena (jena.semanticweb.org)
 - ▶ Popular RDF store
 - ▶ RDF (SparQL) and RDFS (RQL) querying
 - ▶ Limited OWL reasoning
 - ▶ Forward chaining and backward chaining rule engines
 - ▶ Open source implementation in Java
 - ▶ Command-line and Java API access
- ▶ Sesame (sesame.semanticweb.org)
 - ▶ Scalable RDF store
 - ▶ Open source implementation in Java
 - ▶ RDF and RDFS querying
 - ▶ Limited OWL reasoning
 - ▶ Forward chaining rules engine
 - ▶ Java API and HTTP access
- ▶ RDFStore
 - ▶ C-based RDF store
 - ▶ RDQL support

RDF Vocabularies

- ▶ Use existing vocabularies whenever possible!
- ▶ Dublin Core: document metadata
- ▶ vCard: business cards
- ▶ RSS: news feeds
- ▶ FOAF: social links between people

Dublin Core

- ▶ The Dublin Core Metadata Set
 - ▶ standard vocabulary for describing resources
 - ▶ originates from library domain
 - ▶ RDF syntax
 - ▶ keywords
 - ▶ title
 - ▶ description
 - ▶ author
 - ▶ creator
 - ▶ format
 - ▶ date
 - ▶ type
 - ▶ relation
 - ▶ ...

Dublin Core Example



```
view-source: - Source of: http://www.w3.org/Overview-about.rdf
File Edit View Help
<?xml version="1.0" ?>
<rdf:RDF xmlns:rdf="http://www.w3.org/1999/02/22-rdf-syntax-ns#"
  xmlns:rdfs="http://www.w3.org/2000/01/rdf-schema#"
  xmlns:dc = "http://purl.org/dc/elements/1.1/">
  <rdf:Description rdf:about="http://www.w3.org/">
    <dc:subject>World Wide Web Consortium, W3C, World Wide Web, Web,
      WWW, Consortium, computer, access, accessibility, semantic,
      worldwide, W3, HTML, XML, standard, language, technology, link,
      CSS, RDF, XSL, Berners-Lee, Berners, Lee, style sheet, cascading,
      schema, XHTML, mobile, SVG, PNG, PICS, DOM, SMIL, MathML, markup,
      Amaya, Jigsaw, free, open source, software</dc:subject>
    <dc:description>The World Wide Web Consortium (W3C) is about 400
      organizations leading the World Wide Web to its full potential.
      Founded by Tim Berners-Lee, the Web's inventor. The W3C Web site
      hosts specifications, guidelines, software and tools. Public
      participation is welcome. W3C supports universal access, the
      Semantic Web, trust, interoperability, evolvability,
      decentralization, and cooler multimedia.</dc:description>
    <dc:date>2003-03-13</dc:date>
    <dc:format>text/html</dc:format>
    <dc:language>en-US</dc:language>
    <dc:creator>W3C Communications Team</dc:creator>
    <dc:publisher>W3C - World Wide Web Consortium -
      http://www.w3.org/</dc:publisher>
    <dc:rights rdf:resource="http://www.w3.org/Consortium/Legal/copyright-documents"/>
    <rdfs:seeAlso rdf:resource="http://www.w3.org/2000/08/w3c-synd/home.rss"/>
  </rdf:Description>
</rdf:RDF>
```

RSS

- ▶ RDF Site Summary
- ▶ Basic RSS:
 - ▶ channel
 - ▶ title
 - ▶ link
 - ▶ description
 - ▶ items
 - ▶ title
 - ▶ link
 - ▶ description
 - ▶ ...

RSS (Cont'd)

- ▶ RSS 1.0 is RDF-based
 - ▶ Module mechanism for extension; a number of modules is standardized (e.g. Dublin Core)
 - ▶ Allows integration with other RDF-based vocabularies
 - ▶ Allows structured content
 - ▶ Allows reuse of RDF vocabulary
- ▶ RSS 2.0 is XML-based
 - ▶ Extension via namespaces
 - ▶ Limited reuse of vocabulary
 - ▶ More convenient to write

RSS Example



The screenshot shows a web browser window titled "view-source: - Source of: http://www.w3.org/2000/08/w3c-synd/home.rss". The browser's menu bar includes "File", "Edit", "View", and "Help". The main content area displays the XML source code of an RSS feed. The code is color-coded: XML tags are in black, attributes are in blue, and text content is in red. The feed is an RDF-based RSS 1.0 document. It includes namespace declarations for RDF, rdfs, dc, rdf, h, and hr. The channel information includes a title "World Wide Web Consortium", a description "Leading the Web to Its Full Potential...", a link to the W3C website, and a date of 2006-05-29. The items section contains a sequence of seven news items, each with an href attribute pointing to a specific news page on the W3C website.

```
<?xml version="1.0" encoding="us-ascii"?><?xml-stylesheet href="http://www.w3.org/2000/08/w3c-synd/home.rss" type="text/xsl" />
<rdf:RDF xmlns="http://purl.org/rss/1.0/"
  xmlns:rdfs="http://www.w3.org/2000/01/rdf-schema#"
  xmlns:dc="http://purl.org/dc/elements/1.1/"
  xmlns:rdf="http://www.w3.org/1999/02/22-rdf-syntax-ns#"
  xmlns:h="http://www.w3.org/1999/xhtml"
  xmlns:hr="http://www.w3.org/2000/08/w3c-synd/#">
  <channel rdf:about="http://www.w3.org/2000/08/w3c-synd/home.rss">
    <title>World Wide Web Consortium</title>
    <description>Leading the Web to Its Full Potential...</description>
    <link>http://www.w3.org/</link>
    <dc:date>2006-05-29</dc:date>
    <items>
      <rdf:Seq>
        <rdf:li rdf:resource="http://www.w3.org/News/2006#item94"/>
        <rdf:li rdf:resource="http://www.w3.org/News/2006#item93"/>
        <rdf:li rdf:resource="http://www.w3.org/News/2006#item92"/>
        <rdf:li rdf:resource="http://www.w3.org/News/2006#item87"/>
        <rdf:li rdf:resource="http://www.w3.org/News/2006#item89"/>
        <rdf:li rdf:resource="http://www.w3.org/News/2006#item91"/>
        <rdf:li rdf:resource="http://www.w3.org/News/2006#item90"/>
        <rdf:li rdf:resource="http://www.w3.org/News/2006#item85"/>
      </rdf:Seq>
    </items>
  </channel>
</rdf:RDF>
```

Modules in RSS

- ▶ Dublin core
- ▶ Syndication
- ▶ Content
- ▶ <http://web.resource.org/rss/1.0/modules/>

FoaF

- ▶ FoaF: Friend of a Friend
- ▶ Establishing social links between people using RDF
- ▶ Person
 - ▶ name
 - ▶ surname
 - ▶ firstName
 - ▶ homepage
 - ▶ **mbox**
 - ▶ **knows**
 - ▶ ...

Foaf Example

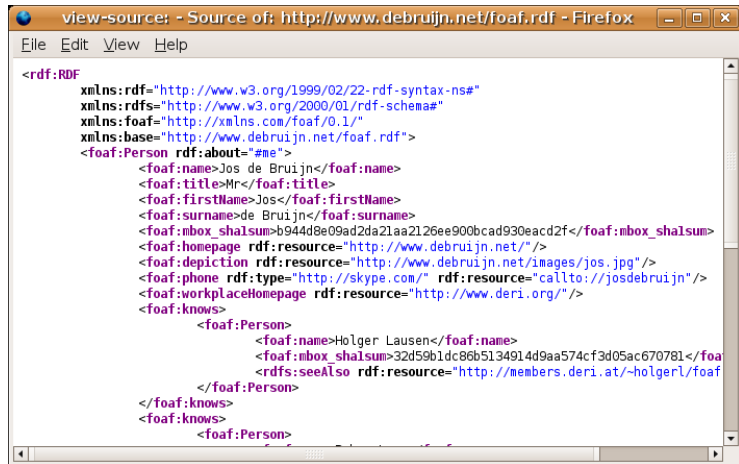

```
view-source: - Source of: http://www.debruijn.net/foaf.rdf - Firefox
File Edit View Help

<rdf:RDF
  xmlns:rdf="http://www.w3.org/1999/02/22-rdf-syntax-ns#"
  xmlns:rdfs="http://www.w3.org/2000/01/rdf-schema#"
  xmlns:foaf="http://xmlns.com/foaf/0.1/"
  xmlns:base="http://www.debruijn.net/foaf.rdf">
  <foaf:Person rdf:about="#me">
    <foaf:name>Jos de Bruijn</foaf:name>
    <foaf:title>Mr</foaf:title>
    <foaf:firstName>Jos</foaf:firstName>
    <foaf:surname>de Bruijn</foaf:surname>
    <foaf:mbox_sha1sum>b944d8e09ad2da21aa2126ee900bcad930eacd2f</foaf:mbox_sha1sum>
    <foaf:homepage rdf:resource="http://www.debruijn.net/">
    <foaf:depiction rdf:resource="http://www.debruijn.net/images/jos.jpg"/>
    <foaf:phone rdf:type="http://skype.com/" rdf:resource="callto://josdebruijn"/>
    <foaf:workplaceHomepage rdf:resource="http://www.deri.org/">
    <foaf:knows>
      <foaf:Person>
        <foaf:name>Holger Lausen</foaf:name>
        <foaf:mbox_sha1sum>32d59b1dc86b5134914d9aa574cf3d05ac670781</foaf:mbox_sha1sum>
        <rdfs:seeAlso rdf:resource="http://members.deri.at/~holger/foaf">
      </foaf:Person>
    </foaf:knows>
  </foaf:Person>
  <foaf:knows>
    <foaf:Person>
```

Ways of Annotating Web Pages

- ▶ Including RDF as Comments
 - ▶ Hard to using existing XML tools
 - ▶ Easy for user (in case of small annotations)
 - ▶ **A comment is a comment**
- ▶ Extending XHTML to include RDF
 - ▶ Simply embed RDF in XHTML
 - ▶ Two approaches:
 1. Invalidate XHTML
 2. Use extended DTD
 - ▶ Embedding is non-standard
- ▶ Using `<link>` tag to connect to external RDF file
 - ▶ Need to maintain additional file

Including RDF as Comments

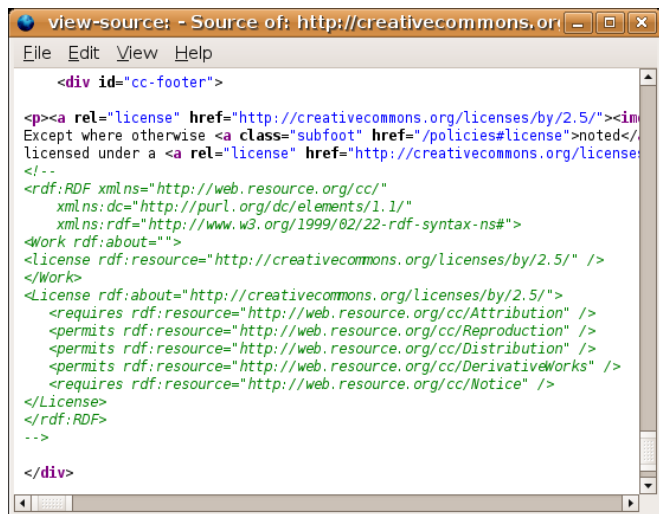

```
view-source: - Source of: http://creativecommons.org
File Edit View Help
<div id="cc-footer">
<p><a rel="license" href="http://creativecommons.org/licenses/by/2.5/"><img alt="Creative Commons License Logo" data-bbox="115 375 145 405"/> Except where otherwise noted, content on this page is licensed under a <a rel="license" href="http://creativecommons.org/licenses/by/2.5/">Creative Commons Attribution 2.5 License</a>.
<!--
<rdf:RDF xmlns="http://web.resource.org/cc/"
  xmlns:dc="http://purl.org/dc/elements/1.1/"
  xmlns:rdf="http://www.w3.org/1999/02/22-rdf-syntax-ns#"
  <Work rdf:about="">
  <license rdf:resource="http://creativecommons.org/licenses/by/2.5/" />
  </Work>
  <license rdf:about="http://creativecommons.org/licenses/by/2.5/">
    <requires rdf:resource="http://web.resource.org/cc/Attribution" />
    <permits rdf:resource="http://web.resource.org/cc/Reproduction" />
    <permits rdf:resource="http://web.resource.org/cc/Distribution" />
    <permits rdf:resource="http://web.resource.org/cc/DerivativeWorks" />
    <requires rdf:resource="http://web.resource.org/cc/Notice" />
  </License>
</rdf:RDF>
-->
</div>
```

Extending XHTML to include RDF (I)

```
<head>
<title>Some Page</title>
<rdf:RDF xmlns:rdf="http://www.w3.org/1999/02/22-rdf-syntax-ns#"
         xmlns:dc="http://purl.org/dc/elements/1.1/">
<rdf:Description rdf:about="http://www.w3.org/"
                 dc:title="W3C Homepage"/>
</rdf:RDF>
</head>
```

Extending XHTML to include RDF (II)

```
<!DOCTYPE html SYSTEM "http://infomesh.net/2002/m12n/test/rdf.txt">

<html xmlns="http://www.w3.org/1999/xhtml"
      xmlns:rdf="http://www.w3.org/1999/02/22-rdf-syntax-ns#"
      xml:lang="en" >
<head>
<title>Embedded RDF Test</title>
<rdf:RDF>
<rdf:Property rdf:about="http://purl.org/net/swn#homepage">
</rdf:Property>
</rdf:RDF>
</head>
```

Using <link> tag to connect to external RDF file

```
<?xml version="1.0" encoding="utf-8"?>
<!DOCTYPE html PUBLIC "-//W3C//DTD XHTML 1.0 Strict//EN" "http://www.w3.org/TR/xhtml1/
<html xmlns="http://www.w3.org/1999/xhtml" xml:lang="en-US" lang="en-US">
<head profile="http://www.w3.org/2000/08/w3c-synd/#"><meta http-equiv="Content-Type" c
<meta name="generator" content="HTML Tidy for Mac OS X (vers 1st March 2004), see ww.

<meta name="keywords" content="W3C, World Wide Web, Web, WWW, Consortium, computer, ac
<meta name="description" content="W3C's nearly 400 member organizations lead the World

<title>World Wide Web Consortium</title>
<link id="meta" rel="rel:meta" href="http://www.w3.org/2000/08/w3c-synd/#meta" />
<link rel="meta" href="/Overview-about.rdf" />
<link rel="stylesheet" type="text/css" href="/StyleSheets/home.css" />
<link rel="stylesheet" type="text/css" href="/StyleSheets/W3C10-home.css" />
<link rel="bookmark" href="#technologies" title="Technologies |" />
<link rel="bookmark" href="#news" title="News |" />
<link rel="bookmark" href="#search" title="Search |" />
<link rel="bookmark" href="#contents" title="Contents |" />
<link rel="bookmark" href="#Offices" title="Offices |" />
<link rel="bookmark" href="#systems" title="Systems |" />
<link rel="bookmark" href="#donors" title="Donors |" />
<link rel="bookmark" href="#footnotes" title="Footnotes |" />
<link rel="alternate" type="application/rss+xml" title="RSS" href="http://www.w3.org/2
</head>

<body>
```

GRDDL

Gleaning Resource Descriptions from Dialects of Languages

▶ Problem

- ▶ Multitude of data in HTML/XML format
 - ▶ e.g. title, metadata in HTML
 - ▶ P3P, Atom, etc... in XML
- ▶ Bring this data to “Semantic” world
- ▶ ⇒ extract RDF from HTML/XML
 - ▶ **not** natural language extraction

▶ Solution

- ▶ Use XSLT to transform HTML and XML to RDF/XML
 - ▶ XSLT is standard format for translating between XML formats
 - ▶ many XSLT processors available
- ▶ Attach XSLT transformation to
 - ▶ Types of documents (e.g. HTML, P3P)
 - ▶ Individual documents

Transformations for Types and Individual Documents

- ▶ Detect type of document
 - ▶ Namespace of root element in XML document
 - ▶ e.g. `xmlns="http://www.w3.org/P3Pv1/"`
 - ▶ Value of profile attribute in (X)HTML
 - ▶ e.g. `<html profile="http://...">`
 - ▶ XSLT associated with type **known** to GRDDL processor
- ▶ Specify transformation
 - ▶ Attribute of root element of XML document
 - ▶ e.g.
`xmlns:data-view="http://www.w3.org/2003/g/data-view#" data-view:transformation="http://..."`
 - ▶ `<link>` tag in HTML
 - ▶ e.g. `<link rel="transformation" href="http://...">`

GRDDL Transformation Example

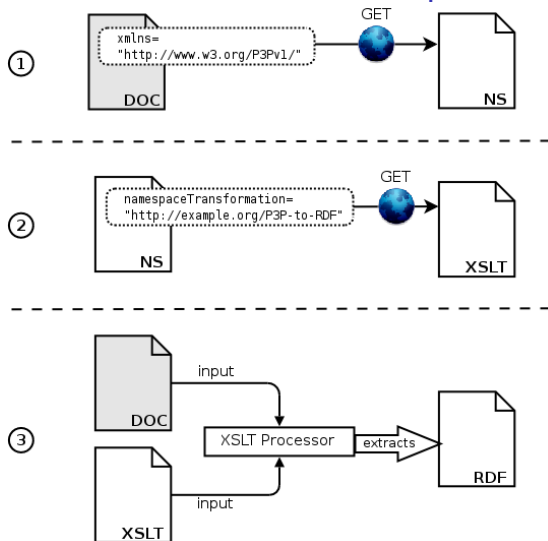

Building Test Cars

- ▶ Test cars test configurations of **parts**
 - ▶ e.g. combine gear box of type x with engine of type y and lever of type z
- ▶ Often, configurations obviously do not work
 - ▶ e.g. lever does not fit in gear box, brakes too weak for engine. etc...
- ▶ Misconfiguration very costly
- ▶ Solution:
 - ▶ Formally model parts
 - ▶ Describe dependencies between parts

Scenario

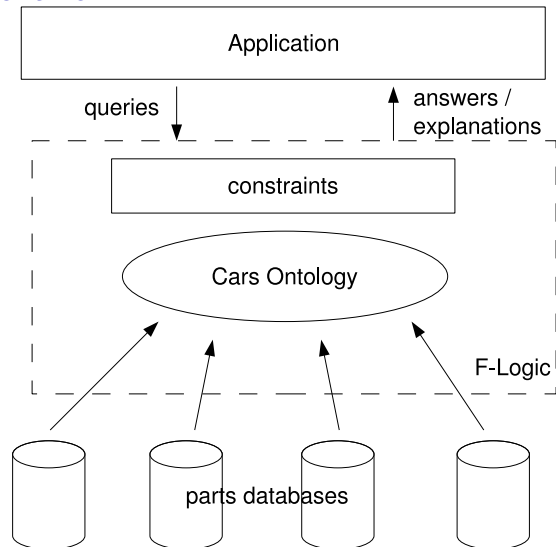

Database Mapping

- ▶ Create “flat” ontology with one-to-one correspondence with DB
 - ▶ table \leftrightarrow concept, column \leftrightarrow attribute
- ▶ Create mappings between ontologies

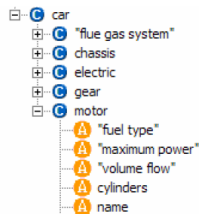
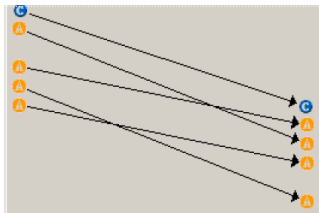
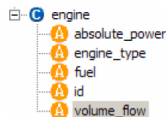

Constraints

Rule 1: The maximum power of the motor must not exceed the one of the brakes: $P_{\text{motor}} < |P_{\text{brakes}}|$

```
message("The motor's maximum power exceeds the one of  
the brakes.")
```

```
!- X:testcar[hasMotor->Y;hasBrake->Z], Y[maximum_power->>Z1],  
Z[maximum_power->>Z2], abs(Z1,Z3), lessorequal(Z2,Z3).
```

Rule 2: The filter installed in a catalyst must be able to filter the motor's fuel.

```
message("The installed filter uses another fuel type  
than the motor")
```

```
!- X:motor[fuel_type->>Z1], Y:filter[fuel_type->>Z2], not equal(Z1,Z2).
```

Summary

RDF Applications

- RDF stores

- RDF vocabularies

- Connecting Web and Semantic Web

- GRDDL

Using F-Logic for Modeling Test Cars

Required reading

- ▶ E. Dumbill: XML Watch: Finding friends with XML and RDF, 2002.
<http://www-128.ibm.com/developerworks/xml/library/x-foaf.html>
- ▶ GRDDL:
<http://www.idealliance.org/proceedings/xttech05/papers/03-06-01/>
- ▶ H-P. Schnurr, J. Angele: Automotive Industry Experience with Semantic Guides. ISWC 2005: 1029-1040

Further reading

- ▶ J. Angele, E. Mönch, H. Oppermann, D. Wenke: Halo I: A Controlled Experiment for Large Scale Knowledge Base Development. LPNMR 2005: 26-39
- ▶ Dublin Core <http://dublincore.org/>
- ▶ RSS <http://web.resource.org/rss/1.0/>
- ▶ FOAF <http://xmlns.com/foaf/0.1/>,
<http://www.foaf-project.org/>